

**U
N
I
K
I
N
G**

TECHNICAL Practice

TELECOM SOLUTIONS FOR THE 21ST CENTURY

1600A Series

**ADA Compliant
Emergency Phones**

August 24, 2004

ADA* Compliant Emergency Phones with Built-In Digital Voice Announcer



The **1600A Series** ADA Compliant Emergency Phones are designed to provide quick and reliable handsfree communication for any standard analog telephone line or analog phone system station port. All **1600A Series** phones meet ADA requirements for elevator/ emergency telephones, and can be programmed from any Touch Tone phone. The phones can dial up to 5 programmable emergency numbers, as well as 2 central station numbers. In addition, the **E-1600-20A** and **E-1600-52A** feature a second "INFO" button that will dial up to 3 non-emergency numbers.

The **1600A Series** phones can be programmed to automatically deliver a digital announcement to identify the location of the emergency call. Alternatively, a DTMF Touch Tone code may also be delivered. A "Call Connected" LED can be initiated manually or automatically. All programming parameters, including phone numbers and location numbers, are stored in non-volatile E² memory. All units are phone line powered, requiring no batteries or external power and are compatible with common Central Station Monitoring equipment.

For outdoor or harsh environments, select **1600A Series** phones are available with Enhanced Weather Protection (EWP). EWP products feature rubber gaskets and boots, hand soldered silicon sealed connections, gel-filled butt connectors, as well as urethane potted circuit boards with weather sealed, field-adjustable trim pots and DIP switches for easy on-site programming.

Features

- Meets ADA requirements for Emergency Phones:
 - Can automatically light the "Call Connected" LED for the hearing impaired
 - Transmits a unique location I.D. code or voice announcement
 - Grade 2 Braille label for the visually impaired
- Non-volatile digital voice announcer with 16 seconds of voice memory
- Advanced call progress detection
- Handsfree operation
- Phone line powered
- Non-volatile E² memory (no batteries required)
- Touch Tone or pulse dialing
- Dials up to 5 emergency numbers
- E-1600-20A and E-1600-52A dial up to 3 non-emergency "INFO" numbers
- Cycles through backup emergency and non-emergency numbers on busy or no-answer
- Optional Enhanced Weather Protection (EWP)  Need More Information on EWP? Call (715) 386-4345 and select 859.
- Hangs up on CPC, silence, busy signal, dial tone, time-out or Touch Tone command
- Programmable to auto-answer on incoming calls
- Remotely programmable
- Extended temperature range (-15°F to 130°F)
- 7 different chassis or board only available
- Available in a 42" tall tower phone model E-1600-BLT-EWP
- Central Station Monitoring capability (dials 2 numbers)
- Separate central station voice speed dial number
- Optional PB-100 Polling System available
- Optional BLK-3-EWP strobe light kit available

Applications

- Elevators
- Parking ramps/lots
- ATM machines
- Area of refuge locations
- Lobbies
- Entryways
- Campus emergency stations
- Roadside emergency stations
- Stadiums
- Convention centers

** Americans with Disabilities Act of 1992 contains federal regulations regarding elevator telephones (Public Law 101-336).*

Specifications

Power: Telephone line powered, 24V DC talk battery with 20mA loop current minimum

Dimensions: See Installation and Specifications

Operating Temperature: -26° C to 54° C (-15° F to 130° F)

Humidity - Standard Products: 5% to 95% non-condensing

Humidity - EWP Products: Up to 100%

CAUTION - When installing on an analog extension of a phone system: Some phone systems do not conform to analog telecom standards and might not be compatible with the 1600A Series emergency phones. For a detailed description of the telephone line specifications required for any of the 1600A Series phones, retrieve Fax Back Document 869.

IF YOU HAVE A PROBLEM WITH A VIKING PRODUCT, PLEASE CONTACT: VIKING TECHNICAL SUPPORT AT (715) 386-8666

Our Technical Support Department is available for assistance Monday 8am - 4pm and Tuesday through Friday 8am - 5pm central time. So that we can give you better service, before you call please:

1. Know the model number, the serial number and what software version you have (see serial label).
2. Have your Technical Practice in front of you.
3. It is best if you are on site.

RETURNING PRODUCT FOR REPAIR

The following procedure is for equipment that needs repair:

1. Customer must contact Viking's Technical Support Department at 715-386-8666 to obtain a Return Authorization (RA) number. The customer MUST have a complete description of the problem, with all pertinent information regarding the defect, such as options set, conditions, symptoms, methods to duplicate problem, frequency of failure, etc.
2. Packing: Return equipment in original box or in proper packing so that damage will not occur while in transit. Static sensitive equipment such as a circuit board should be in an anti-static bag, sandwiched between foam and individually boxed. All equipment should be wrapped to avoid packing material lodging in or sticking to the equipment. Include ALL parts of the equipment. C.O.D. or freight collect shipments cannot be accepted. Ship cartons prepaid to:
Viking Electronics, 1531 Industrial Street, Hudson, WI 54016
3. Return shipping address: Be sure to include your return shipping address inside the box. We cannot ship to a PO Box.
4. RA number on carton: In large printing, write the R.A. number on the outside of each carton being returned.

RETURNING PRODUCT FOR EXCHANGE

The following procedure is for equipment that has failed out-of-box (within 10 days of purchase):

1. Customer must contact Viking's Technical Support at 715-386-8666 to determine possible causes for the problem. The customer MUST be able to step through recommended tests for diagnosis.
2. If the Technical Support Product Specialist determines that the equipment is defective based on the customer's input and troubleshooting, a Return Authorization (R.A.) number will be issued. This number is valid for fourteen (14) calendar days from the date of issue.
3. After obtaining the R.A. number, return the approved equipment to your distributor, referencing the R.A. number. Your distributor will then replace the product over the counter at no charge. The distributor will then return the product to Viking using the same R.A. number.
4. **The distributor will NOT exchange this product without first obtaining the R.A. number from you. If you haven't followed the steps listed in 1, 2 and 3, be aware that you will have to pay a restocking charge.**

WARRANTY

Viking warrants its products to be free from defects in the workmanship or materials, under normal use and service, for a period of one year from the date of purchase from any authorized Viking distributor or 18 months from the date manufactured, whichever ever is greater. If at any time during the warranty period, the product is deemed defective or malfunctions, return the product to Viking Electronics, Inc., 1531 Industrial Street, Hudson, WI, 54016. Customer must contact Viking's Technical Support Department at 715-386-8666 to obtain a Return Authorization (R.A.) number.

This warranty does not cover any damage to the product due to lightning, over voltage, under voltage, accident, misuse, abuse, negligence or any damage caused by use of the product by the purchaser or others.

Viking's sole responsibility shall be to repair or replace (at Viking's option) the material within the terms stated above. VIKING SHALL NOT BE LIABLE FOR ANY LOSS OR DAMAGE OF ANY KIND INCLUDING INCIDENTAL OR CONSEQUENTIAL DAMAGES RESULTING DIRECTLY OR INDIRECTLY FROM ANY BREACH OF ANY WARRANTY EXPRESSED OR IMPLIED, OR FOR ANY OTHER FAILURE OF THIS PRODUCT. Some states do not allow the exclusion or limitation of incidental or consequential damages, so this limitation may not apply to you.

THIS WARRANTY IS IN LIEU OF ALL OTHER WARRANTIES, EXPRESSED OR IMPLIED, INCLUDING THE WARRANTIES OF MERCHANTABILITY AND FITNESS FOR A PARTICULAR PURPOSE, WHICH ARE HEREBY EXCLUDED BEYOND THE ONE YEAR DURATION OF THIS WARRANTY. Some states do not allow limitation on how long an implied warranty lasts, so the above limitation may not apply to you.

FCC REQUIREMENTS

This equipment complies with Part 68 of the FCC rules. Located on the equipment is a label that contains, among other information, the FCC registration number and ringer equivalence number (REN). If requested, this information must be provided to the telephone company.

The REN is used to determine the quantity of devices which may be connected to the telephone line. Excessive REN's on the telephone line may result in the devices not ringing in response to an incoming call. In most, but not all areas, the sum of the REN's should not exceed five (5.0). To be certain of the number of devices that may be connected to the line, as determined by the total REN's, contact the telephone company to determine the maximum REN for the calling area.

This equipment cannot be used on the telephone company-provided coin service. Connection to Party Line Service is subject to State Tariffs.

If this equipment causes harm to the telephone network, the telephone company will notify you in advance that temporary discontinuance of service may be required. If advance notice isn't practical, the telephone company will notify the customer as soon as possible. Also, you will be advised of your right to file a complaint with the FCC if you believe it is necessary.

The telephone company may make changes in its facilities, equipment, operations, or procedures that could affect the operation of the equipment. If this happens, the telephone company will provide advance notice in order for you to make the necessary modifications in order to maintain uninterrupted service.

If trouble is experienced with this equipment, please contact: *Viking Electronics, Inc., 1531 Industrial Street, Hudson, WI 54016 (715) 386-8666*

If the trouble is causing harm to the telephone network, the telephone company may request you to remove the equipment from the network until the problem is resolved.

The E-1600A Series phones use the USOC jack RJ11C.

It is recommended that the customer install an AC surge arrester in the AC outlet to which this device is connected. This is to avoid damaging the equipment caused by local lightning strikes and other electrical surges.

This equipment is Hearing-Aid Compatible (HAC).

The telephone Consumer Protection Act of 1991 makes it unlawful for any person to use a computer or other electronic device, including fax machines, to send any message unless such message clearly contains in a margin at the top or bottom of each transmitted page or on the first page of the transmission, the date and time it is sent and an identification of the business or other entity, or other individual sending the message and the telephone number of the sending machine or such business, other entity, or individual. (The telephone number provided may not be a 900 number or any other number for which charges exceed local or long-distance transmission charges.)

PART 15 LIMITATIONS

This equipment has been tested and found to comply with the limits for a Class A digital device, pursuant to Part 15 of the FCC Rules. These limits are designed to provide reasonable protection against harmful interference when the equipment is operated in a commercial environment. This equipment generates, uses, and can radiate radio frequency energy and, if not installed and used in accordance with the instruction manual, may cause harmful interference to radio communications. Operation of this equipment in a residential area is likely to cause harmful interference in which case the user will be required to correct the interference at his own expense.

Installation and Specifications

A. Standard 1600A Series Phone

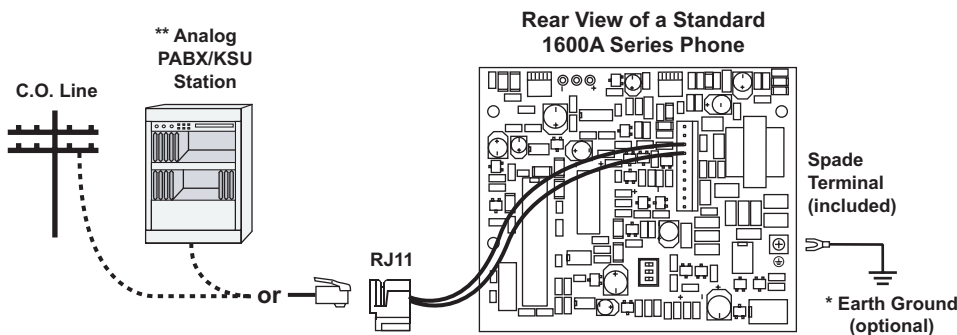

IMPORTANT: Electronic devices are susceptible to lightning and power station electrical surges from both the AC outlet and the telephone line. It is recommended that a surge protector be installed to protect against such surges. Contact Panamax at (800) 472-5555 or Electronic Specialists Inc. at (800) 225-4876.

*** Note:** To increase surge protection, loosen the PCB mounting screw labeled (as shown) and fasten a wire with spade terminal (included) from the mounting screw to Earth Ground (grounding rod, water pipe, etc.)

B. 1600A Series Phone with EWP

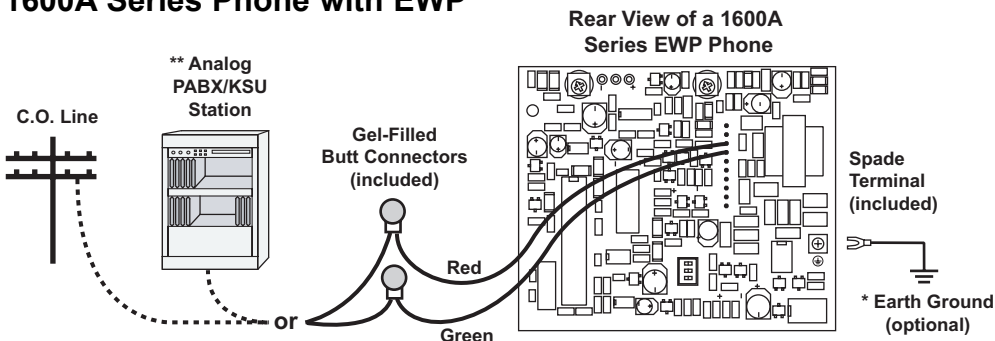

**** Note:** When installing a line powered phone on a low voltage and/or low loop current phone system extension, a PS-2R Talk Battery/Loop Current boosting power supply may be required.



Need More Information on the PS-2R?
Call (715) 386-4345 and select 512.

E-1600A and E-1600-45A (optional EWP available)

Dimensions: 133mm x 102mm x 51mm (5.25" x 4.0" x 2.0")

Shipping Weight: 1.13 kg (2.5 lbs.)

Material: .062" (16 gauge) steel, **E-1600A** - Red powder paint, **E-1600-45A** - High visibility yellow powder paint

Connections: Standard **E-1600A/E-1600-45A** - RJ11, **E-1600A-EWP/E-1600-45A-EWP** - Gel-filled butt connectors

Mounting: Surface mount to walls, posts, single gang boxes or 4" x 4" electrical junction boxes or recess mount in elevator phone boxes.

Optional Enhanced Weather Protection (EWP): The optional **EWP** products feature sealed trim pots, sealed DIP switches, hand soldered and silicon sealed connections, rubber boots and gaskets, urethane potted circuit boards and gel-filled butt connectors.

Need More Information on EWP?
Call (715) 386-4345 and select 859.

Note: For greater weather resistance, apply a bead of clear silicon caulking around the top edge and sides of the chassis

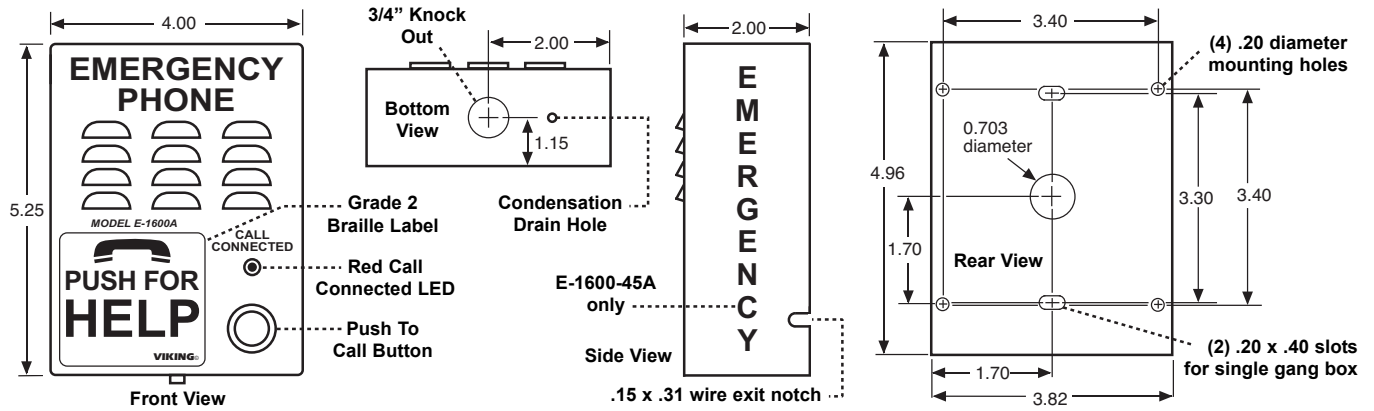

E-1600-02A

Dimensions: 330mm x 267mm x 51mm (13" x 10.5" x 2")

Shipping Weight: 3.18 kg (7 lbs.)

Connections: RJ11

Material: .125" (11 gauge) brushed stainless steel

Mounting: Flush mount in elevator cabs, ATMs, stairwells, hallways, etc.

Suggested Hardware: (6) #8 x 3/4 flat head phillips sheet metal type A screws (not included)

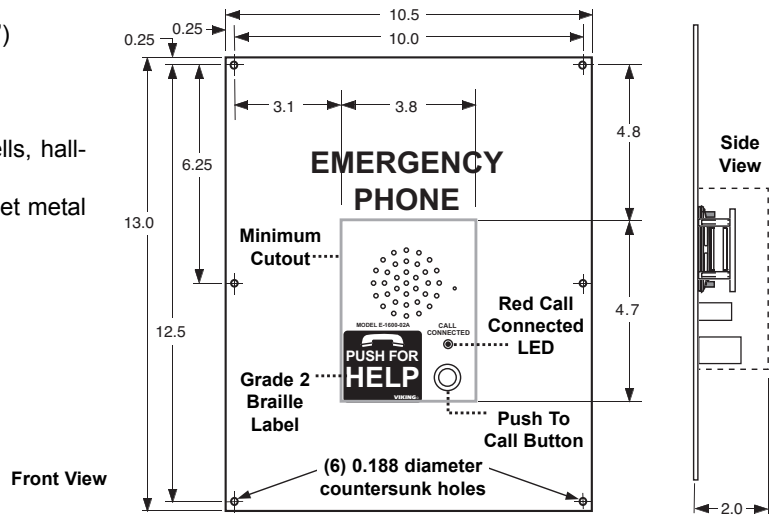

K-1600-EHFA

Dimensions: 251mm x 174mm x 53mm (9.875" x 6.86" x 2.10")

Shipping Weight: .91 kg (2 lbs.)

Material: .062" (16 Gauge) Red powder painted steel

Connections: RJ11

Mounting: Recess mounted in standard elevator phone box (10.0" x 7.0" x 3.0")

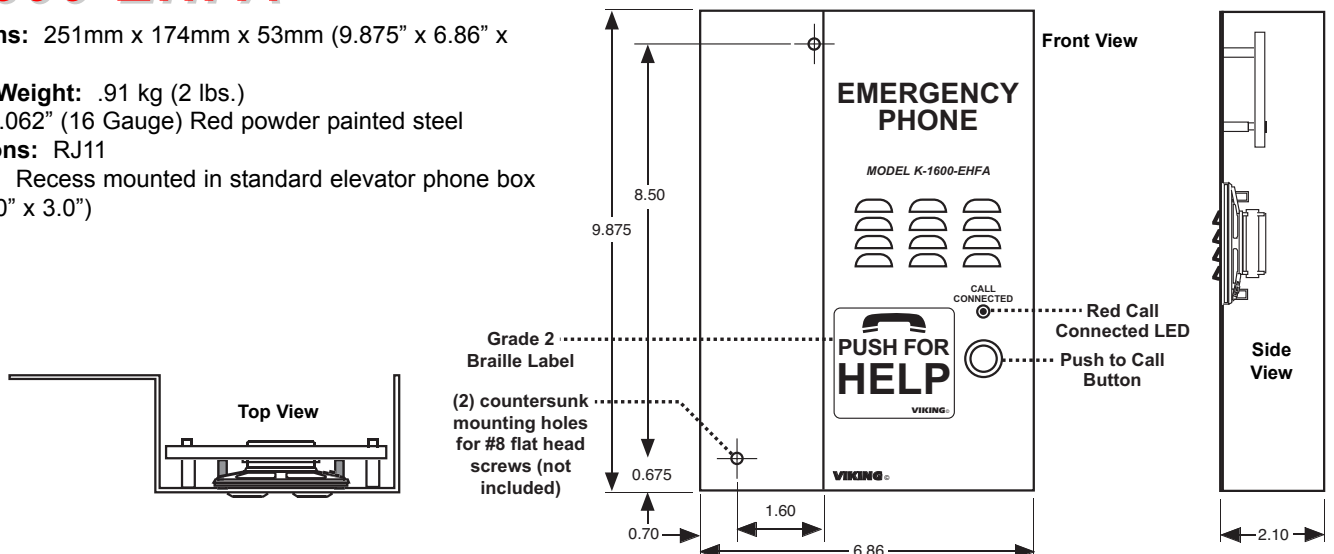

E-1600-20A (optional EWP available)

Dimensions: Overall - 127mm x 127 x 57mm (5.0" x 5.0" x 2.25"), Plastic Electrical Box - 102mm x 102mm x 54mm (4.0" x 4.0" x 2.14")

Shipping Weight: 1 kg (2.12 lbs.)

Front Panel Material: 14 gauge brushed stainless steel

Connections: Standard E-1600-20A - RJ11, E-1600-20A-EWP - Gel-filled butt connectors

Optional Enhanced Weather Protection (EWP): The optional EWP products feature sealed trim pots, sealed DIP switches, hand soldered and silicon sealed connections, rubber boots and gaskets, urethane potted circuit boards and gel-filled butt connectors.

Mounting with Plastic Rough-In Box (included): Flush into walls, mounts to side of wall stud **Mounting with Optional VE-5x5:** Surface mount to walls, single gang boxes, double gang boxes, posts, or to a Viking VE-GNP Gooseneck pedestal (see options below).

Caution: When warm air comes in contact with cold surfaces, such as outside walls and conduits, it causes condensation. To prevent condensation from accumulating inside the E-1600-20A always bring conduit into the bottom of the unit. If this is not possible, drill a 1/4" diameter hole in the bottom of the black plastic box.

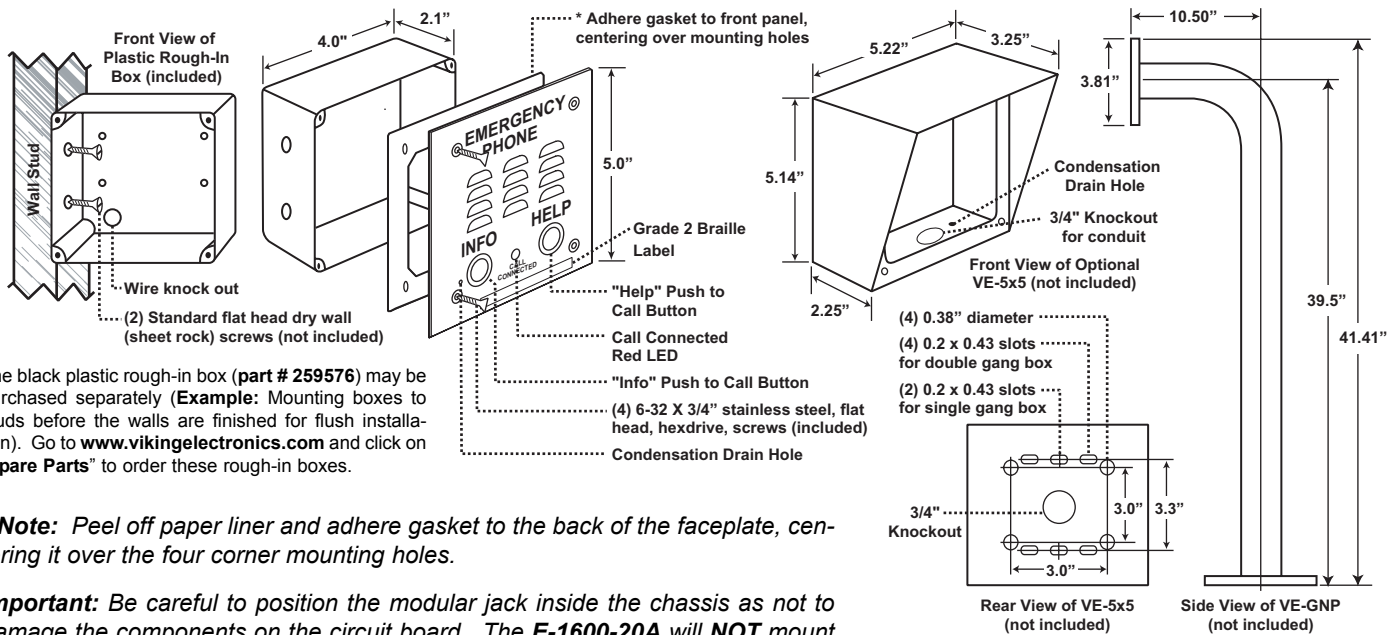

The black plastic rough-in box (part # 259576) may be purchased separately (Example: Mounting boxes to studs before the walls are finished for flush installation). Go to www.vikingelectronics.com and click on "Spare Parts" to order these rough-in boxes.

* **Note:** Peel off paper liner and adhere gasket to the back of the faceplate, centering it over the four corner mounting holes.

Important: Be careful to position the modular jack inside the chassis as not to damage the components on the circuit board. The E-1600-20A will NOT mount to a standard double gang box.

Need More Information on the VE-5x5 or VE-GNP? Call (715) 386-4345 and select 424.

E-1600-03B (optional EWP available)

Dimensions: 183mm x 149mm x 39mm (7.22" x 5.86" x 1.55")

Material: .074" (14 gauge) Brushed stainless steel panel and extra heavy duty button with LED

Shipping Weight: 1.36 kg (3 lbs.)

Connections: Standard E-1600-03B - RJ11, E-1600-03B-EWP - Gel-filled butt connectors

Mounting: Surface mounted to walls, posts, single gang boxes, double gang boxes or 4" x 4" electrical junction boxes or recess mount in elevator phone boxes.

Optional Enhanced Weather Protection (EWP): The optional EWP products feature sealed trim pots, sealed DIP switches, hand soldered and silicon sealed connections, rubber boots and gaskets, urethane potted circuit boards and gel-filled butt connectors.

Note: For greater weather resistance, apply a bead of clear silicon caulking around the top edge and sides of the chassis

Need More Information on EWP? Call (715) 386-4345 and select 859.

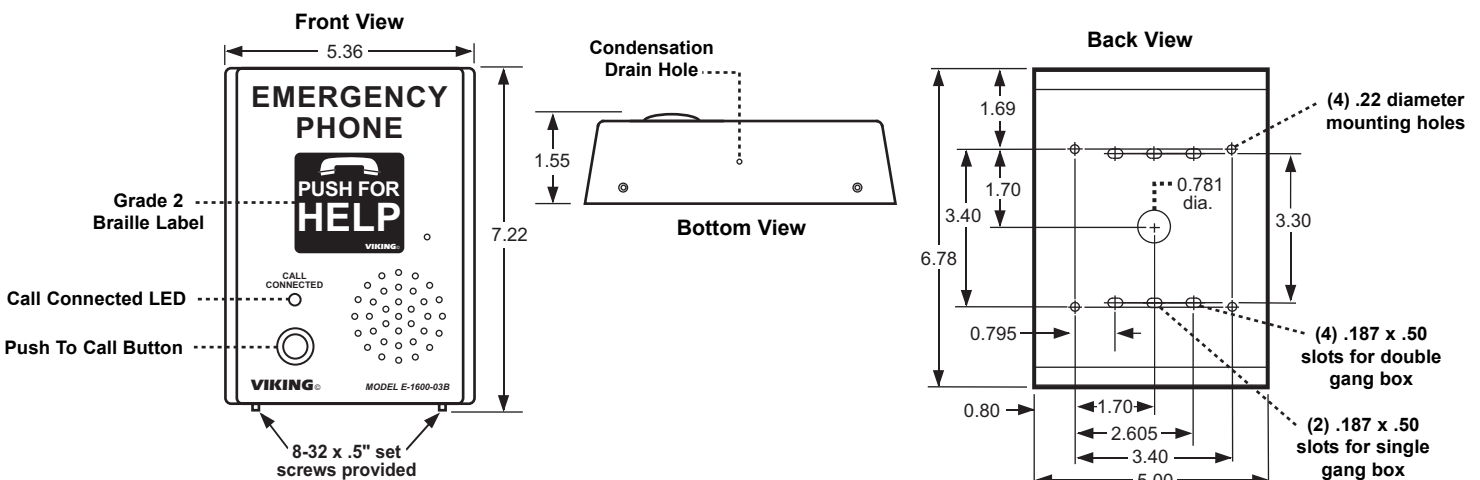

E-1600-50A/52A (optional EWP available)

Note: This is a 1600A parts kit without chassis.

Shipping Weight: .45 kg (1 lb)

Connections: Standard E-1600-50A/52A - RJ11, E-1600-50A-EWP/52A-EWP - Gel-filled butt connectors

Optional Enhanced Weather Protection (EWP): The optional EWP products feature sealed trim pots, sealed DIP switches, hand soldered and silicon sealed connections, rubber boots and gaskets, urethane potted circuit boards and gel-filled butt connectors.

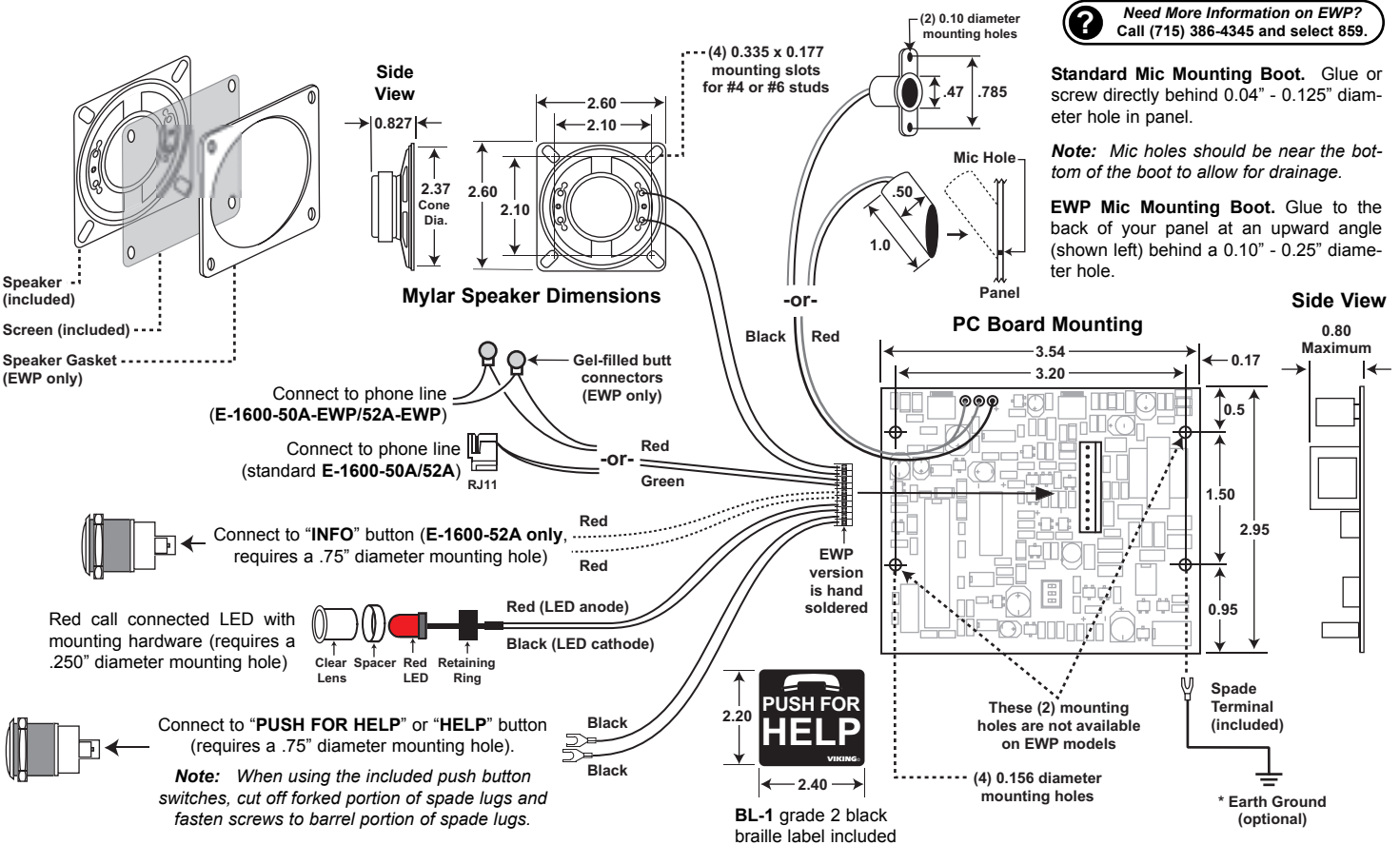

Important: If installing the EWP version outdoors, apply non-corrosive silicone (included with EWP version) to back side of LED and push button switches after making all connections and testing. Completely encapsulate exposed switch connections (screw terminals/stripped wires) and bare wire connections.

E-1600-55A (optional EWP available)

The E-1600-55A is a universal emergency phone kit for installing behind elevator panels, or an installation requiring a custom panel. The finished panel should provide: (4) studs (#6 diameter minimum) for mounting plate, audio holes for speaker and microphone, a momentary SPST push button switch and a 0.25" diameter mounting hole for the LED. Alternatively, the LED can be cut off and the wires connected to a integral switch with LED (often found in elevators). **Note:** An LED must be connected to the red and black wires for the phone to operate.

Optional Enhanced Weather Protection (EWP): The optional EWP products feature sealed trim pots, sealed DIP switches, hand soldered and silicon sealed connections, rubber boots and gaskets, urethane potted circuit boards and gel-filled butt connectors.

Need More Information on EWP?
Call (715) 386-4345 and select 859.

Shipping Weight: .73 kg (1.6 lb)

Connections: Telco - RJ-11 jack or wire nuts, Switch - spade terminals

Material: 0.062" thick (16 gauge) zinc plated steel

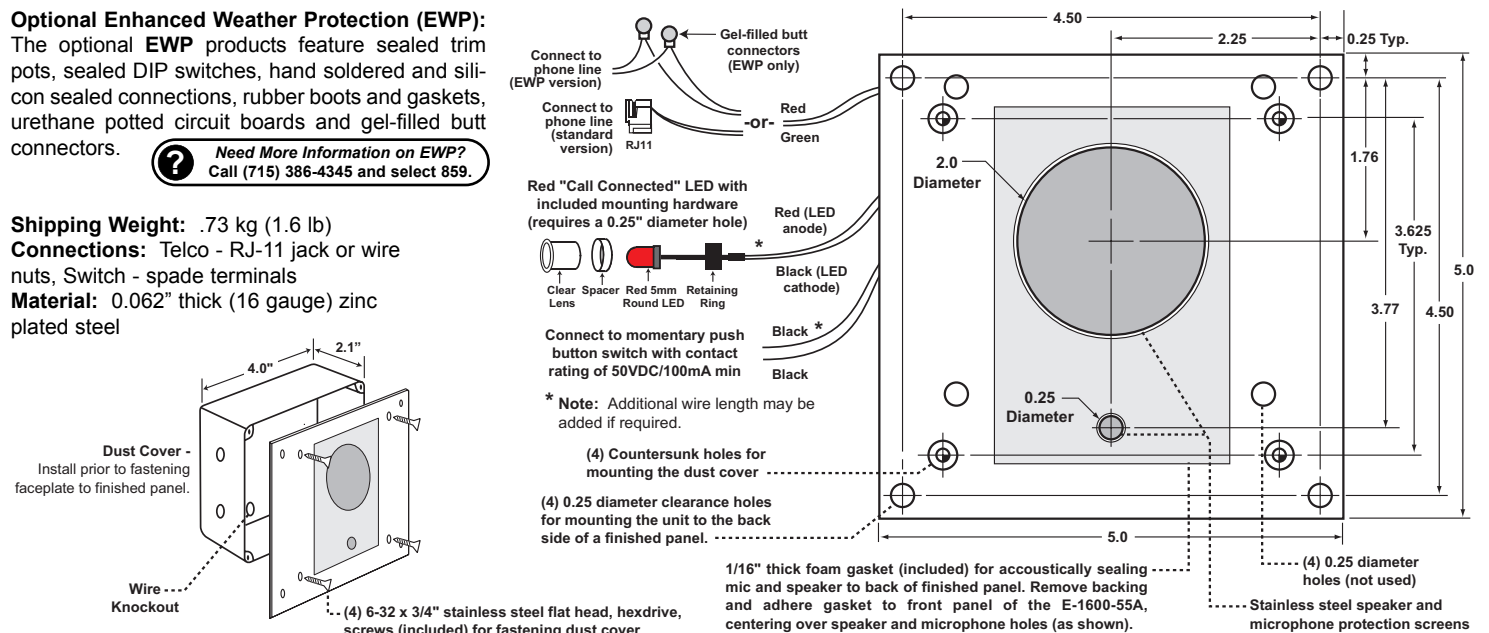

Programming

A. Accessing the Programming Mode

The **1600A Series** emergency phones can be programmed from any Touch Tone phone using a C.O. line, analog PABX/KSU station, or a **DLE-200B** Line Simulator.

 **Need More Information on the DLE-200B?**
Call (715) 386-4345 and select 605.

1. Using the Security Code

Step 1.	Move DIP switch 2 to the ON position (sets unit to answer incoming calls, see section J).
Step 2.	From a Touch Tone phone call the line attached to the 1600A Series phone.
Step 3.	When the 1600A Series phone answers, enter the 6-digit security code (factory set to 845464 , see section C). A double beep should then be heard indicating you have entered the programming mode.

2. Without the Security Code

Step 1.	Move DIP switch 2 to the ON position (sets unit to answer incoming calls, see section J).
Step 2.	Move DIP switch 3 to the OFF position (incoming calls enter Programming without security code, see section J).
Step 3.	From a Touch Tone phone call the line attached to the 1600A Series phone.
Step 4.	When the 1600A Series answers, a double beep will be heard and will automatically enter the programming mode.
Step 5.	When finished programming, move DIP switch 3 back to the ON position (see section J).

B. Quick Programming Features

	Enter Digits	- then -	Enter Memory Location
First emergency speed dial number	0-20 digits	then	#00
Second emergency speed dial number	0-20 digits	then	#01
Third emergency speed dial number	0-20 digits	then	#02
Fourth emergency speed dial number	0-20 digits	then	#03
Fifth emergency speed dial number	0-20 digits	then	#04
Central station receiver number	0-20 digits	then	#05
Central station voice number	0-20 digits	then	#06
First "Info" speed dial number (E-1600-20A and E-1600-52A only)	0-20 digits	then	#07
Second "Info" speed dial number (E-1600-20A and E-1600-52A only)	0-20 digits	then	#08
Third "Info" speed dial number (E-1600-20A and E-1600-52A only)	0-20 digits	then	#09
Voice announcer options (factory set to 000000)	6 digits	then	#17
Timing/Dialing options (factory set to 234111)	6 digits	then	#18
Security code (factory set to 845464)	6 digits	then	#19
Identification number (factory cleared)	0-20 digits	then	#20
To add a * at any point in the dialing string	**		
To add a # at any point in the dialing string	*#		
To add a four second pause at any point in the dialing string	*7		
To switch to pulse dialing at any point in the dialing string	*6		
To clear any speed dial number	(no digits)	then	#00 - #09

Note: A double beep indicates a valid memory position, four beeps indicate an error.

C. Security Code (memory location #19)

The security code allows the user/installer to program the **1600A** series phone while DIP switch **3** is in the **ON** (normal) position. The factory set security code is 845464 (V-I-K-I-N-G). It is recommended that the factory set security code be changed. **Example:** To store 123456 as the security code:

Step 1.	Access programming as shown in Programming section A.
Step 2.	Enter 123456 #19 ..
Step 3.	Hang-up.

Enter Your Security Code Here:					
					#19

Note: The security code must be 6 digits and cannot include a ***** or a **#**.

D. Speed Dial Numbers

Note: Up to 20 digits can be stored in each dial position. Special features such as pause, mode change, Touch Tone * and # count as single digits.

1. Emergency Speed Dial Numbers (memory locations #00 - #04)

The emergency speed dial number programmed in location #00 is the number that is dialed when the "HELP" / "CALL" button is first pressed. Additional speed dial numbers will be dialed when there is no answer or a busy signal is detected and the next number redial features are activated. To program, enter the desired speed dial number followed by the location number (#00 - #04). To clear a speed dial location, simply enter the memory location (#00 - #04) alone. The 1600A series phone is factory set with no speed dial number programmed.

To Program:	Enter:
*	**
#	*#
4 second pause	*7
switch to pulse mode	*6
0, 1, 2...9	0, 1, 2...9

2. "INFO" Speed Dial Numbers (E-1600-20A/52A Only) (memory locations #07 - #09)

The information speed dial number programmed in location #07 is the telephone or extension number that is dialed when the "INFO" button is first pressed. Additional information speed dial numbers will be dialed when there is no answer or a busy signal is detected and the next number redial features are activated. The E-1600-20A phone will cycle through the programmed speed dial numbers until answered. To program, enter the desired speed dial number followed by the location number (#07 - #09). To clear a speed dial location, simply enter the location (#07 - #09) alone.

3. Speed Dial Programming Examples

To Program the 1600A Series Phone...	Step 1 - See Section A	Step 2 - Enter Digits:
...to store 555-1234 as the first emergency speed dial number	Enter Programming	5 5 5 1 2 3 4 # 0 0
...to store a Touch Tone 9, a four second pause and then a pulse dialed 333-4444 into the second "Info" speed dial memory position	Enter Programming	9 *7 *6 3 3 3 4 4 4 4 # 0 8
...to clear the first emergency speed dial number	Enter Programming	# 0 0

E. Identification Number (memory location #20)

The Touch Tone I.D. number (up to 20 digits) is used by emergency personnel to identify the location of the caller and is given out when the receiving party presses a Touch Tone *. The security office can display the number using a Touch Tone decoder. To program the I.D. number, enter the desired number followed by #20. **Example:** To store 333 as the I.D. number, enter: 3 3 3 # 2 0

F. Timing/Dialing Options (memory location #18)

There are six positions in the timing/dialing options. To program these options, enter the six desired timing/dialing numbers followed by #18. The six available timing/dialing options are defined as follows:

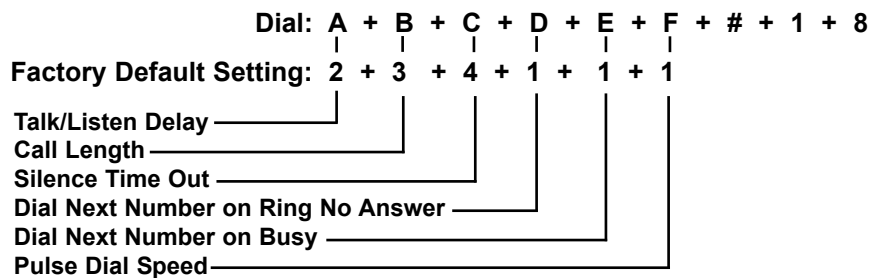

Enter Timing/Dialing Settings Here:					
A	B	C	D	E	F
<input type="text"/>	<input type="text"/>	<input type="text"/>	<input type="text"/>	<input type="text"/>	<input type="text"/>

#18

Setting A - Talk/Listen Delay

This feature selects switching time between talk and listen modes (VOX switching time). Use chart at the right. * **Note:** The factory default is .2 seconds.

Touch Tone	Talk/Listen Delay
1	.1 sec
2	.2 sec *
3	.3 sec
4	.4 sec
5	.5 sec
6	.6 sec
7	.7 sec
8	.8 sec
9	.9 sec

Setting B - Call Length Time Out

This feature selects the maximum length of time that calls can be connected. Programmable in increments of 1 minute up to a maximum of 9 minutes (Touch Tones 1 - 9). Program 0 in this location to disable the call length time out. With the call length disabled, the **1600A** series phone must rely on a CPC signal, busy signal, silence or return to dial tone to hang-up. Use chart at the right. * **Note:** *The factory default is 3 minutes.*

Touch Tone	Call Length Time Out
0	Disabled
1	1 min
2	2 min
3	3 min*
4	4 min
5	5 min
6	6 min
7	7 min
8	8 min
9	9 min

Setting C - Silence Time Out

This feature selects the length of time that calls will remain connected without voice activity. Programmable in increments of 10 seconds up to a maximum of 90 seconds (Touch Tones 1 - 9). To disable the silence time out, program 0 in this location. Use chart at the far right. * **Note:** *The factory default is 40 seconds.*

Touch Tone	Silence Time Out
0	Disabled
1	10 sec
2	20 sec
3	30 sec
4	40 sec*
5	50 sec
6	60 sec
7	70 sec
8	80 sec
9	90 sec

Setting D - Dial Next Number on Ring No Answer

If enabled and a ring-no-answer is detected, the **1600A** series phone will dial the next programmed speed dial number, and continue to cycle through the emergency numbers until a call is completed. * **Note:** *This feature is disabled in the factory default setting.*

Touch Tone	Setting D
1 or 0	Disabled*
2, 3, 4...9	Dials second number after 2, 3, 4...9 rings respectively

Setting E - Dial Next Number on Busy

If enabled and a busy is detected, the **1600A** series phone will dial the next programmed speed dial number, and continue to cycle through the emergency numbers until a call is completed. * **Notes:** *This feature is disabled in the factory default setting. If the busy signal is interrupted with a promotional message, contact your central office to have it removed.*

Touch Tone	Setting E
1	Disabled*
2	Enabled

Setting F - Pulse Dialing Rate (Pulses per second)

The **1600A** series phone is capable of different pulse dialing speeds. * **Note:** *The factory default setting is 10pps.*

Touch Tone	Setting F
1	10 pps*
2	20 pps

G. Voice Announcer Options (memory location #17)

The **1600A** series phones have a built-in non-volatile digital voice announcer that may be used to identify the location of the emergency phone call. The 16 seconds of digital record time is recorded remotely from a Touch Tone phone. Programming options are as follows:

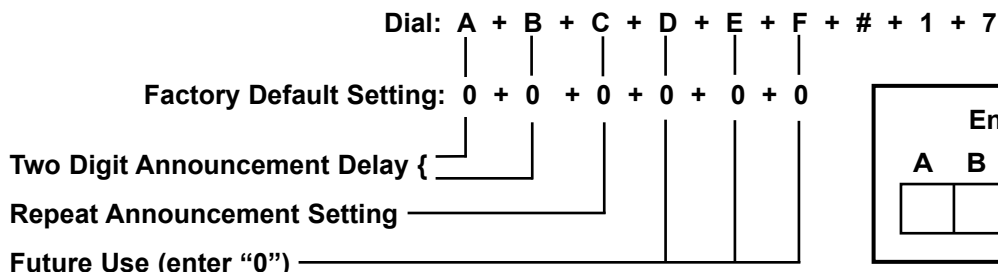

Enter Settings Here:						
A	B	C	D	E	F	
<input type="text"/>	<input type="text"/>	<input type="text"/>	0	0	0	#17

Settings A and B - Announcement Delay

The **1600A** series phone is factory set to automatically start playing the voice announcement after it has determined the call has been answered. Alternately, the announcement may be programmed to play after a programmed amount of time, from 1 to 99 seconds after dialing.

Touch Tone	Setting A/B
00	Play automatically
01-99	1-99 seconds*

* **Note:** *If the announcement delay time is used, you must allow enough time for the **1600A** series phone to detect ring-no-answer and busy signals when using the redial features. The factory default is set to play automatically.*

Setting C - Repeat Announcement Option

The **1600A** can be programmed to play the announcement from 1-9 times, or to continuously repeat the announcement every 8 seconds until a Touch Tone * is detected from the distant party. The I.D. number (if programmed) will be sent and the call connected LED will turn on automatically after the announcement has stopped repeating.

Touch Tone	Setting C
0	Repeat every 8 secs*
1-9	Repeat 1-9 times

* **Note:** The factory default for the **1600A** series phone is to repeat until a * is detected (digit 0).

H. Recording the Announcement

Step 1.	Call into the 1600A series phone with a Touch Tone phone and access programming.
Step 2.	Enter *4 , wait for the tone and then begin recording. Sixteen seconds of record time is available.
Step 3.	Enter any Touch Tone to stop the recording. Playback is automatic.
Step 4.	Enter *5 to review the announcement again.
Step 5.	If you choose to not use a voice announcement, enter *3 to clear the recording.

Example: “Elevator number 1215, located in the Financial Building, needs assistance. Press the asterisk (*) key on your telephone to start and stop this announcement...”

I. Automating the Call Connected LED

There are two methods of turning on the Call Connected LED. The LED will turn on after a Touch Tone * is detected from the distant party or after the voice announcer is finished playing a programmed number of times. If you want the Call Connected LED to light automatically when the call has been answered, but you don't want a voice announcement to be played, follow these programming steps:

Step 1:	Step 2:	Step 3:
Access Programming as shown in section A	Make a short (1 second) recording of silence	Enter digits: 001000#17

J. DIP Switch Programming/Speaker and Microphone Adjustments

Two POTs are provided to increase or decrease speaker volume and microphone sensitivity. In certain noisy locations the microphone sensitivity may need to be decreased as shown below. **Caution:** Setting the microphone gain too high may cause distorted audio, prevent the distant party from breaking over and inhibit second number redialing.

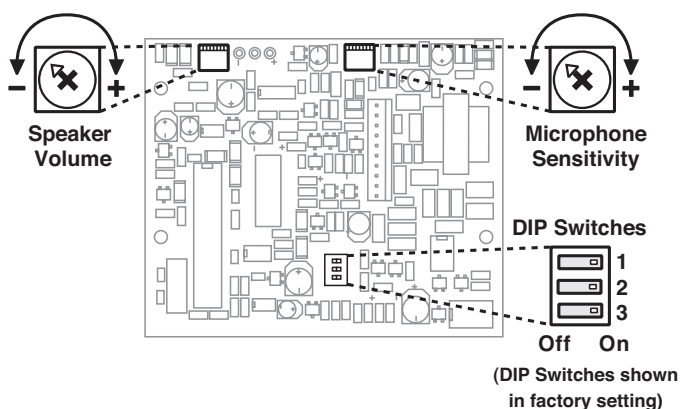

DIP Switch	Position	Description
1	ON	“HELP” / “CALL” button alternately connects and disconnects calls (factory default)
1	OFF	“HELP” / “CALL” button connects calls only
2	ON	Incoming calls answered (factory setting)
2	OFF	Incoming calls are not answered
3	ON	Normal operation mode (factory setting)
3	OFF	Learn mode - Any incoming calls are automatically entered into the programming mode (no security code required). Use this option if you have forgotten your security code.

K. Central Station Programming

The standard **1600A** emergency phone is capable of communicating using the “Ademco Contact I.D.”, “Ademco High Speed”, “DTMF 4+1 Express”, or the “DTMF 4+2 Express” formats. All formats use the programming memory location **#20** to store the account code and alarm details.

1. Central Station Programming Features

a. Accessing the Programming Mode

Before programming, you must access the programming mode (see **Programming** section A).

b. Enabling/Disabling Central Station Mode

The **1600A** Series emergency phone can be placed in the “Central Station Mode” by entering a central station phone number in position **#05** while programming. To cancel the “Central Station Mode,” clear position **#05** by entering **#05** only (see **Programming** section D).

c. Ring Delay

When the **1600A** Series emergency phone is in the “Central Station Mode”, it is best to have the ring delay set to a minimum of three, because some receivers send a long tone after answering the line that sounds like a ring back. If the **1600A** is set to a ring delay of two, the phone will disconnect (see **Programming** section F).

To Program the 1600A Series Phone...	Step 1:	Step 2 - Enter Digits:
...to enable central station programming and dial 952-2567	Enter Programming	9 5 2 2 5 6 7 # 0 5
...to disable central station programming	Enter Programming	# 0 5

d. Speed Dial Numbers

The **1600A** Series phone can be programmed to dial a central station receiver only, or dial up to 5 voice numbers first, and if no answer, then dial the central station receiver. When calling the first numbers (memory positions **#00-#04** (see **Programming** section D), the phone stays in “two-way talk mode” allowing two-way conversation. When calling the Central Station number (memory position **#05**), the phone is in a “listen only mode” in order to interpret the hand shake signals of the receiver.

A second central station number position has been provided in location **#06** that is used when the central station receiver does not have a talk over mode. If a number is placed in position **#05** and position **#06** is cleared, the **E-1600A** will call the central station monitor receiver. After the receiver sends a kiss-off, the **E-1600A** lights the “Call Connected” LED and goes into two-way talk mode. If numbers are in both positions **#05** and **#06**, the **E-1600A** will call the receiver first, and after the kiss-off, will hang-up and redial the number in position **#06** for two-way voice communication.

Notes: If only a central station is to be dialed, the central station phone number must be preprogrammed in memory location **#05** and memory locations **#00-#04** must be cleared. The “Call Connected” LED will light automatically if there is a voice recording programmed.

Location	Call Type
#00	Voice - Emergency
#01	Voice - Emergency
#02	Voice - Emergency
#03	Voice - Emergency
#04	Voice - Emergency
#05	Central Station Receiver
#06	Central Station Voice Line
#07	Voice - “Info” (E-1600-20A/52A only)
#08	Voice - “Info” (E-1600-20A/52A only)
#09	Voice - “Info” (E-1600-20A/52A only)

2. Central Station Formats

The following examples explain the receiver formats and how to properly program memory location **#20**. Each format starts with a four digit account code. This is the code that is assigned by your central station for billing purposes. You must access the programming mode before programming these features (see **Programming** section A).

Important: If a number is shown, you must use that number. If an “X” is shown, use any appropriate number.

a. Ademco Contact ID Format

This DTMF format consists of a four digit account code, two digit message type, and a nine digit data field.

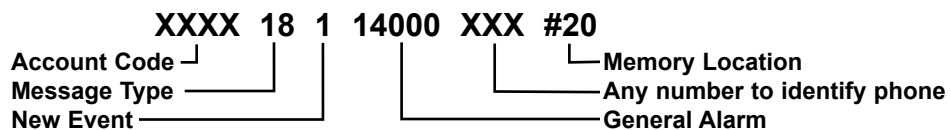

Enter Contact ID Settings Here:	<input style="width: 20px; height: 20px;" type="text"/> <input style="width: 20px; height: 20px;" type="text"/> <input style="width: 20px; height: 20px;" type="text"/> <input style="width: 20px; height: 20px;" type="text"/> 18 1 14000 <input style="width: 20px; height: 20px;" type="text"/> <input style="width: 20px; height: 20px;" type="text"/> <input style="width: 20px; height: 20px;" type="text"/> #20
---------------------------------	--

b. Ademco High Speed Format

This DTMF format consists of a four digit account code, eight zone codes and one alarm type digit. With this format you can identify up to eight different phones by using a zone per phone. A "5" in a zone position means no alarm. The following example shows an alarm from the third phone.

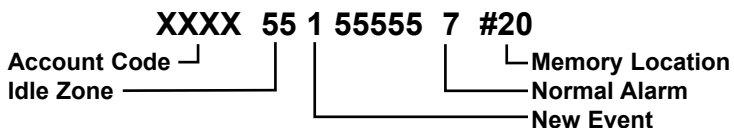

Enter Ademco High Speed ID Settings Here: 55 1 55555 7 #20

c. 4+1 Express Format

This DTMF format consists of a four digit account code, two digit message type, and a single digit event code.

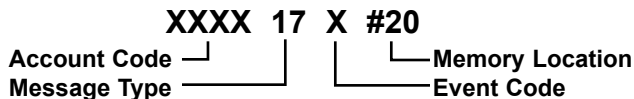

Enter 4+1 Express ID Settings Here: 17 #20

d. 4+2 Express Format

This DTMF format consists of a four digit account code, two digit message type, and a two digit event code.

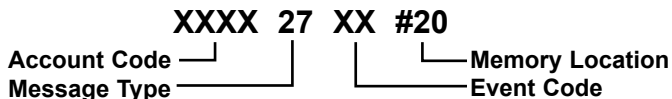

Enter 4+2 Express ID Settings Here: 27 #20

Operation

A. Standard Operation

1. "HELP" / "CALL" Button

When the "HELP" / "CALL" button is pressed, the **1600A** series phone goes off-hook and dials a pre-programmed telephone number. The Call Connected LED momentarily flashes during tone or pulse dialing. In the event that the line is busy or there is a ring-no-answer, the unit can be programmed to call additional phone numbers. The phone then cycles through up to 5 pre-programmed emergency numbers until the call is answered. When the call is answered, handsfree communication to emergency personnel is established. The digital voice announcer will automatically play to identify the location of the emergency call. The * key will stop the announcement, send the I.D. number (if programmed) and light the "Call Connected" LED. Alternatively, the phone can be programmed to automatically light the "Call Connected" LED after the announcement has played a programmed number of times. The distant party will know the location of the emergency call by either the voice announcement or by decoding the Touch Tone I.D. number. Pressing the * key again will send the I.D. number and play the message again. Once the * key has been pressed, the # key can be used to force the phone to hang-up.

2. "INFO" Button (E-1600-20A and E-1600-52A Only)

When the "INFO" button is pressed (**E-1600-20A** and **E-1600-52A** only), the phone goes off-hook and dials the first "INFO" phone number programmed. If a busy signal is detected or the call goes unanswered, the phone will cycle through all three "INFO" phone numbers until the call is answered. When answered, handsfree communication is established. **Note:** The voice announcement is for **Emergency/Help** calls only and will not play on a call initiated from the "INFO" button.

B. Central Station Operation

After the "HELP" / "CALL" button on the 1600A Series phone has been pressed the 1600A Series phone will begin to dial. If a voice number is programmed in memory locations #00-#04, these numbers will be dialed first. Upon detecting a busy signal or after a preprogrammed ring delay the 1600A Series phone will hang-up and dial the central station phone number stored in memory location #05. When the central station receiver answers, it will send a handshake tone to the 1600A phone. Upon detecting the handshake tone, the 1600A Series phone will begin uploading the information stored in memory location #20.

Once the 1600A Series emergency phone has sent the information stored in memory location #20, it waits for a "kiss-off" tone from the central station. When the "kiss-off" tone is received, the emergency phone turns on the call connected LED and goes into the "two-way talk mode" or hangs up and dials position #06 if programmed. **Note:** The central station should have a "talk-over" feature that will allow a two way conversation at this time. If your receiver does not support a "talk-over". A voice phone number should be programmed into position #06. If the central station answers the call and does not send a "kiss-off", the next number will be dialed (if programmed). In either single number or multi-number programming, the phone will keep dialing until a call is completed.

Options

Enhanced Weather Protection (EWP)

Some applications demand the extra protection of EWP. For example: phones that are exposed to the elements, a corrosive atmosphere, or vehicle exhaust all need the extra weather and corrosion resistance of EWP. EWP is available on the following Viking models: E-1600A, E-1600-03B, E-1600-20A, E-1600-45A, E-1600-50A, E-1600-52A/55A, K-1700-3, E-1600A-BLT-EWP and BLK-3-EWP.



? Need More Information on EWP?
Call (715) 386-4345 and select 859.



PB-100 System

PB-100 Polling and Diagnostics Kit

The PB-100 system provides centralized polling and diagnostics of all Viking 1600 and 1600A series emergency phones through a standard Windows 9x/NT P.C. In addition, any device or human capable of returning DTMF Touch Tones can be automatically polled.

Up to 500 individual phones can be polled, at timed intervals, for the diagnosis of proper programming and operation.

? Need More Information on the PB-100?
Call (715) 386-4345 and select 860.



BLK-3-EWP

BLK-3-EWP Strobe Light Kit

The BLK-3-EWP can be used to add emergency notification to pre-installed emergency phones. The BLK-3-EWP is equipped with Enhanced Weather Protection (EWP) and will not flash on "Info" calls when used with the E-1600-20A or E-1600-52A. Alternatively, the BLK-3-EWP provides high visibility indication of analog line status through a high powered strobe light. The BLK-3-EWP is an ideal solution for the hearing impaired and can be used equally well in loud warehouses or factories, where ringing phones can not be heard.

? Need More Information on the BLK-3-EWP?
Call (715) 386-4345 and select 653.

Special Housing

A variety of special housing is available for the 1600A Series emergency phones. The VE-5x5 surface mount backbox may be used with the E-1600-20A-EWP to allow surface mounting or mounting to a gooseneck pedestal.

? Need More Information on the VE-5x5?
Call (715) 386-4345 and select 424.

The weatherproof VE-9x12 may be used with the E-1600A, E-1600-03B, E-1600-20A and E-1600-45A for extreme weather and vandal protection. The VE-9x12 is available in yellow or red.

? Need More Information on the VE-9x12?
Call (715) 386-4345 and select 413.



VE-9x12



E-1600A-BLT-EWP

42" Tall ADA Tower Phone with Integrated Blue Strobe Light

Provide added safety for your patrons, employees, and students with the addition of high-visibility, ADA Compliant emergency communication. At the push of a button, the E-1600A-BLT-EWP (shown right) will initiate a call to your emergency personnel and send a digital announcement to identify the location of the emergency call. In addition, the Tower Phone's bright (1million candle power) Strobe Light will instantly begin pulsating to deter further activity and make it fast and easy for Police or Security personnel to locate the site of the emergency. The phone comes complete with Enhanced Weather Protection (EWP), as shown above.

? Need More Information on the E-1600A-BLT-EWP?
Call (715) 386-4345 and select 217.

Product Support Line...715.386.8666

Fax Back Line...715.386.4345

Due to the dynamic nature of the product design, the information contained in this document is subject to change without notice. Viking Electronics, and its affiliates and/or subsidiaries assume no responsibility for errors and omissions contained in this information. Revisions of this document or new editions of it may be issued to incorporate such changes.